



PCS-64-KRX Power Control System

Thank you for purchasing XTC's Power Control System. The kit comes complete with everything needed for installation. All switch circuit/housings are wired for bottom row lighting for use with optional up-graded Carling lit switches. The system has six circuits, two 10 amp direct and three 20-amp and one 30-amp relayed circuits with Diode protection that reduce voltage spikes from field collapse, protecting LED lights and other sensitive accessories. The kit includes power wire with a 50 Amp Circuit breaker for overall circuit protection. More installation information can be found at www.xtcinstall.com

Please read the instructions fully and familiarize yourself with the components before starting the install.

Remember that the System can be mounted in other places not shown. The install instructions included is just one of many places that the system can be installed.

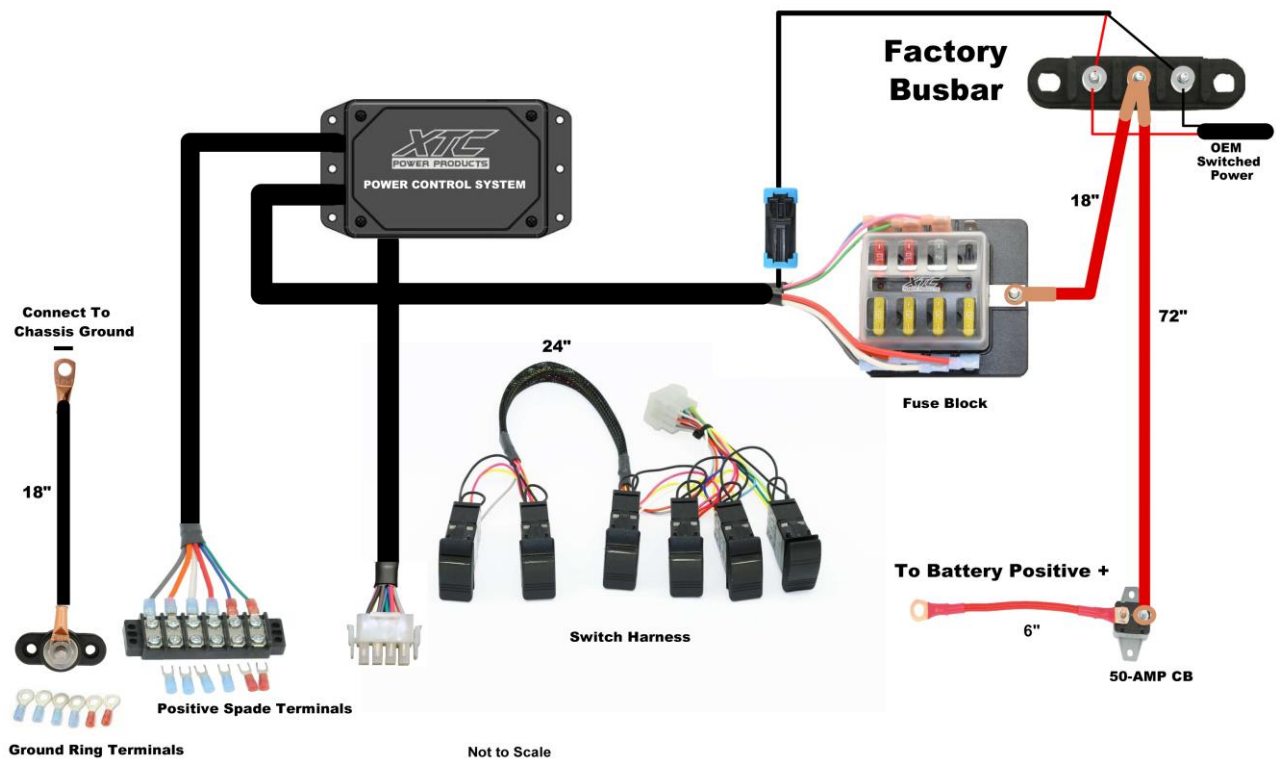

1. Disconnect the Battery by detaching the Ground Cable from the battery

2. Remove Center dash console giving access to inside the dash. Mount the Power Control System box on the top of the center console using the supplied screws as shown below right.

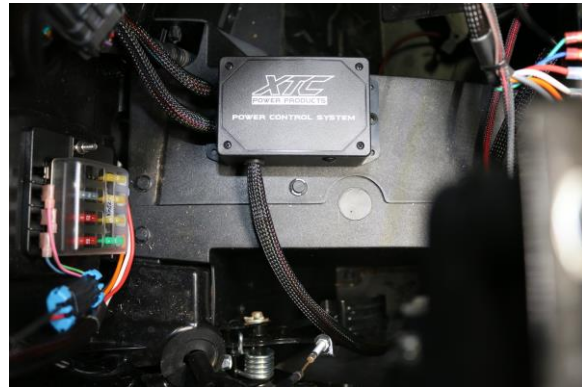

3. Mount the Fuse Box on the fire wall above the control box.

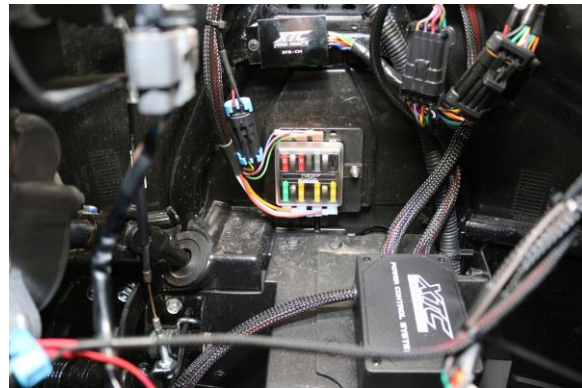
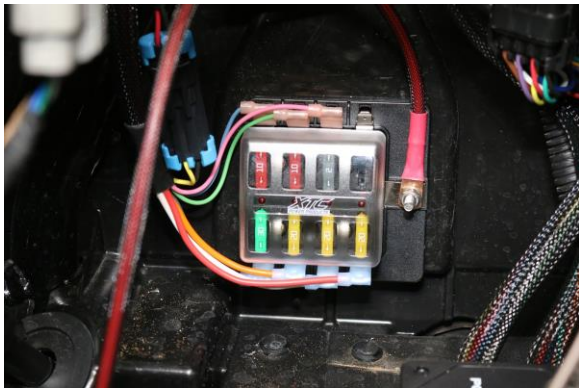

4. Mount the 50-Amp Circuit Breaker next to the battery



5. Attach the 18" long Red 8GA power wire from the Fuse Block over to the center post on the factory Busbar

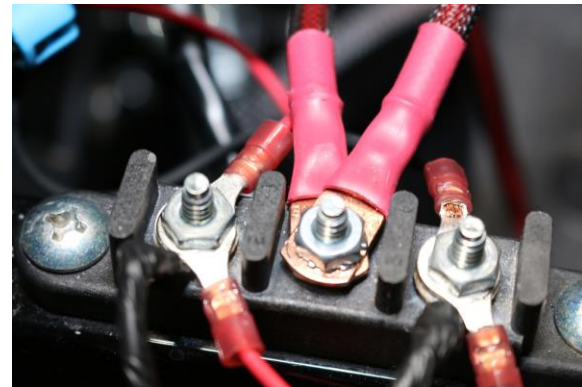
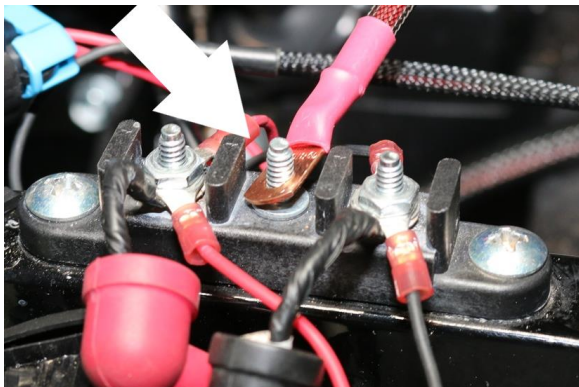

6. Attach the Long 6' 8GA wire to the Busbar and install Keps Nut, run cable down through center console to the Circuit Breakers Silver Screw terminal and attach. The 6" cable that is attached to the copper terminal now gets attached to the positive Battery Post.

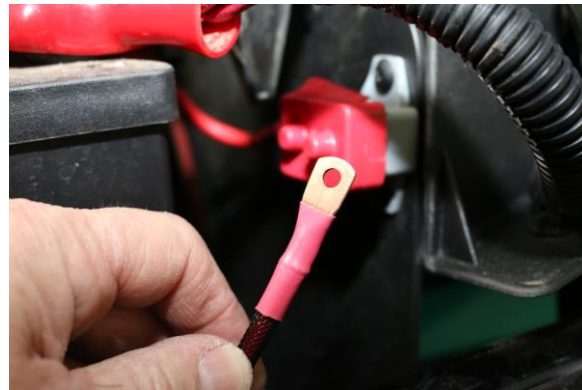
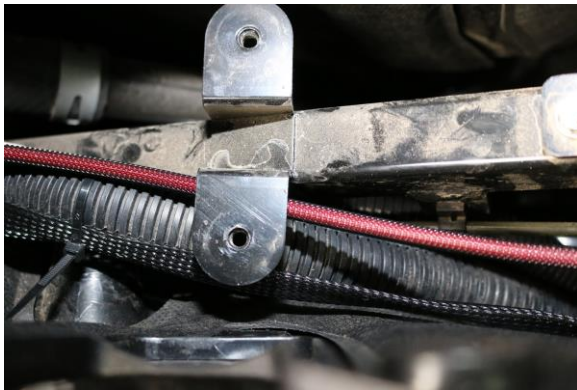
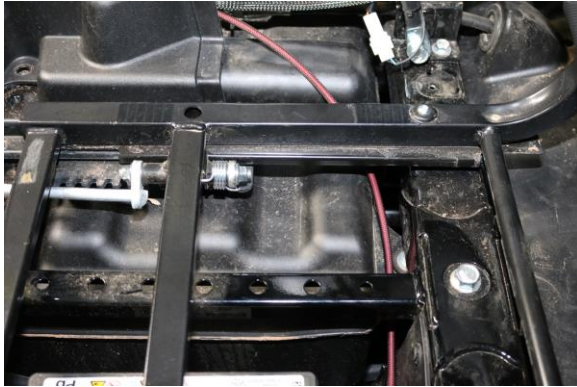

7. Plug the two-pin power connector into the fuse box and run the other end over to the factory Busbar, attach the red wire to the Left 12vdc post and the Black wire to the Right Ground Post, see picture in STEP 5.
8. Mount the Terminal Block with the supplied screws.

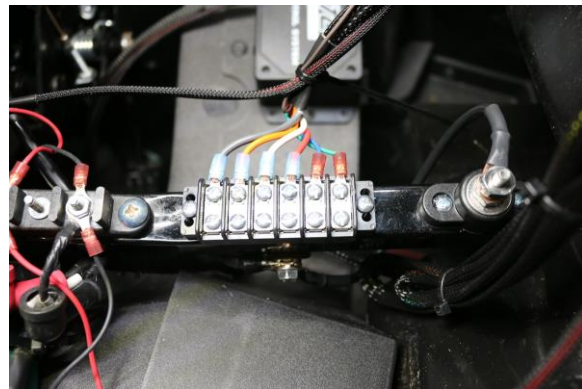
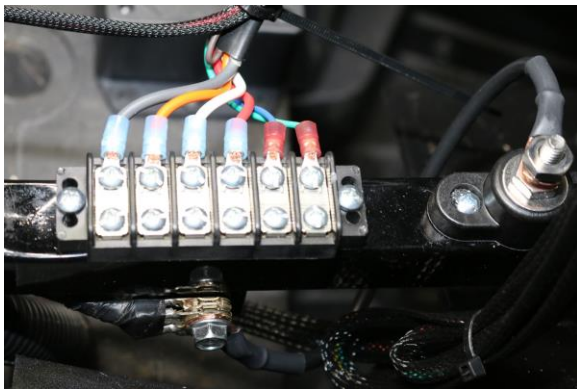

9. Mount the 1/4" Ground Stud – next to the Terminal Block. Run the 8GA Black cable from the stud to the OEM Ground bolt below where the Terminal Block was mounted. Use the provided 1/4" Ring terminals to attach grounds to each device.
10. Mount the switches in the Dash – Using a new box cutter, cut out the rectangles for the switches. **NOTE:** Switch 1 and 2 are extended to be able to mount on the left-hand side of the Dash if desired.

11. Mount each switch, take the switch harness and plug onto the switches.

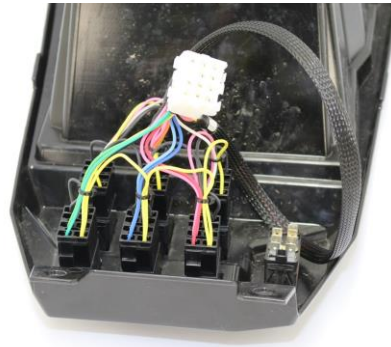

12. Connect the power wire from the devices to be controlled to the appropriate terminal on the terminal strip making sure to attach the devices ground to the ground stud provided. Switch 1 through 4 should be used for your larger accessories and are on power relays, switch 5 and 6 the power goes through the switch and are used for smaller items like whip light, interior lighting or stereo. The following are the switch designations.

1. Terminal 1 is Grey and is on relay 1 controlled by switch 1 with 30-amp fuse
2. Terminal 2 is Orange and is on relay 2 controlled by switch 2 with 20-amp fuse
3. Terminal 3 is White and is on relay 3 controlled by switch 3 with 20-amp fuse
4. Terminal 4 is Red and is on relay 4 controlled by switch 4 with 20-amp fuse
5. Terminal 5 is Blue and is direct and controlled by switch 5 with 10-amp fuse. **Not included on PCS-44**
6. Terminal 6 is Green and is direct and controlled by switch 6 with 10-amp fuse. **Not included on PCS-44**

13. Connect the 12-pin connector to the control box and reinstall the center dash.

14. Re-Connect Battery Ground

15. Verify operation.

NOTE: The PCS-64 comes with our new Fuse Block that is equipped with a Blown Fuse Indicator. If any of the fuses are blown the LED will come on when the device's switch is turned on.

Cables and switches can be purchased at www.xtcpowerproducts.com

We can be reached by email at support@xtcpowerproducts.com

XTC Power Products
A Division of XTC Motorsports LLC
380 E Comstock Dr.
Chandler AZ 85225
480-558-8588
www.xtcpowerproducts.com

*Disclaimer: This kit is intended for off-road use only, and XTC Motorsports claims no responsibility for its use. It is up to the purchaser to ensure it complies with all Federal, State, and Local laws. R2m

Copyright © 2022 XTC MOTORSPORTS LLC, all rights reserved.